

código code

VARIOS

Bombas de Mano Hand Pumps



Descripción Description

Estos dispositivos introducen presión manualmente en el circuito o la descargan a tanque. Pueden utilizarse como dispositivos de emergencia en caso de fallo eléctrico.

These devices get pressure into the circuit or they, leak to tank. It can be used as an emergency devides when an electrical failure occurs.

Datos Principales Main Data

Código Grupos Bombeo Pumping Groups Code		Desplazamiento Displacement	Presión Max. Max. Pressure	A	B	Peso Weight (Kg)				
Tipo de Grupo Group Type						2 L	3 L	5 L	7 L	10 L
Doble Efecto Double Effect	Simple Efecto Simple Effect	(cm ³ /cycle)	(bar)	mm.	mm.					
900726	900426	12	315	110	219	6.00	6.00	6.20	6.50	9.60
900826	900526	25	250	110	229	6.00	6.00	6.20	6.50	9.60
900926	900626	45	220	114	237	6.30	6.30	6.50	6.80	9.90
Codigos Depósitos Completos (Plástico) Complete Tanks Code (Plastic)						901926	902026	902126	902226	-
Codigos Depósitos Completos (Aluminio) Complete Tanks Code (Aluminium)						902826	902926	903026	903126	901826

código code

VARIOS

Bombas de Mano Hand Pumps

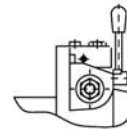
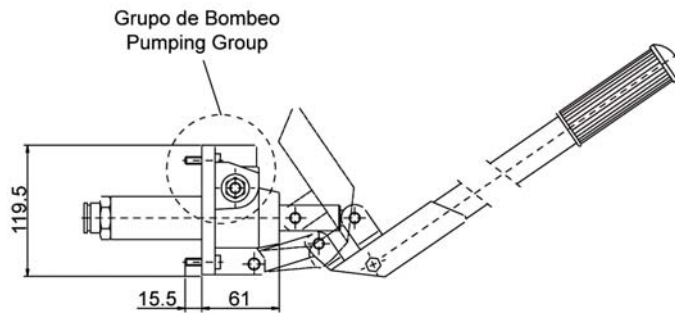

Grupo Bombeo Doble Efecto
con Válvula de seguridad
Pumping group Double Effect
with safety valve

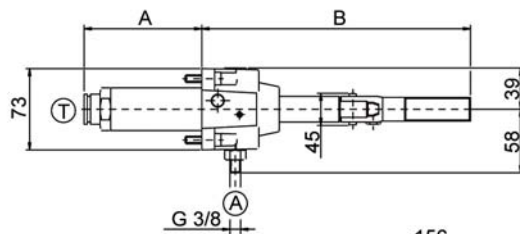

Grupo Bombeo Simple Efecto
Con Válvula de Seguridad
Pumping Group Simple Effect
With Safety Valve

Soporte para Deposito Remoto
Support for Remote Tank

901026

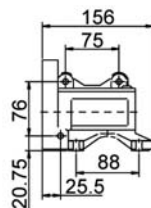

Deposito 1L
Tank 1 Lt

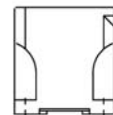

901126

Deposito 2L. (Standard)
Tank 2 Lt. (Standard)

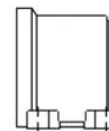

Combinar estas tapas con deposito 2 L. para convertir a dep. 2,3,5,7 y 10 L
Combine this covers with 2 Lt. tank for convert to 2,3,5,7 & 10 Lt. tanks

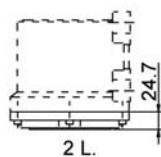

2 L.

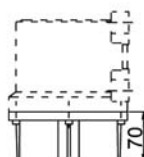

3 L.

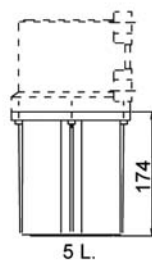

5 L.

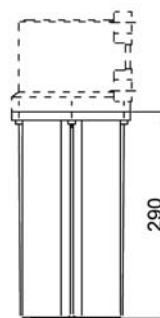

7 L.

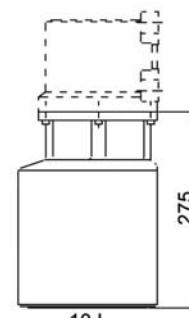

10 L.

IMPORTANTE / IMPORTANT

Las válvulas de serie, pueden fijarse entre 0+140 bar.
También disponibles con rango entre 70+300 bar.
Consultar otras configuraciones a Dpto. Comercial.

The supplies valves, could be setting between 0+140 bar.
Besides available with pressures range between 70+300 bar
Consult other possibilities with Sales Department.